

CE

凱昆 **KACON**  
機電·工控

# 电容式传感器选型

*Selection of Capacitive Sensors*

---方形电容式接近传感器

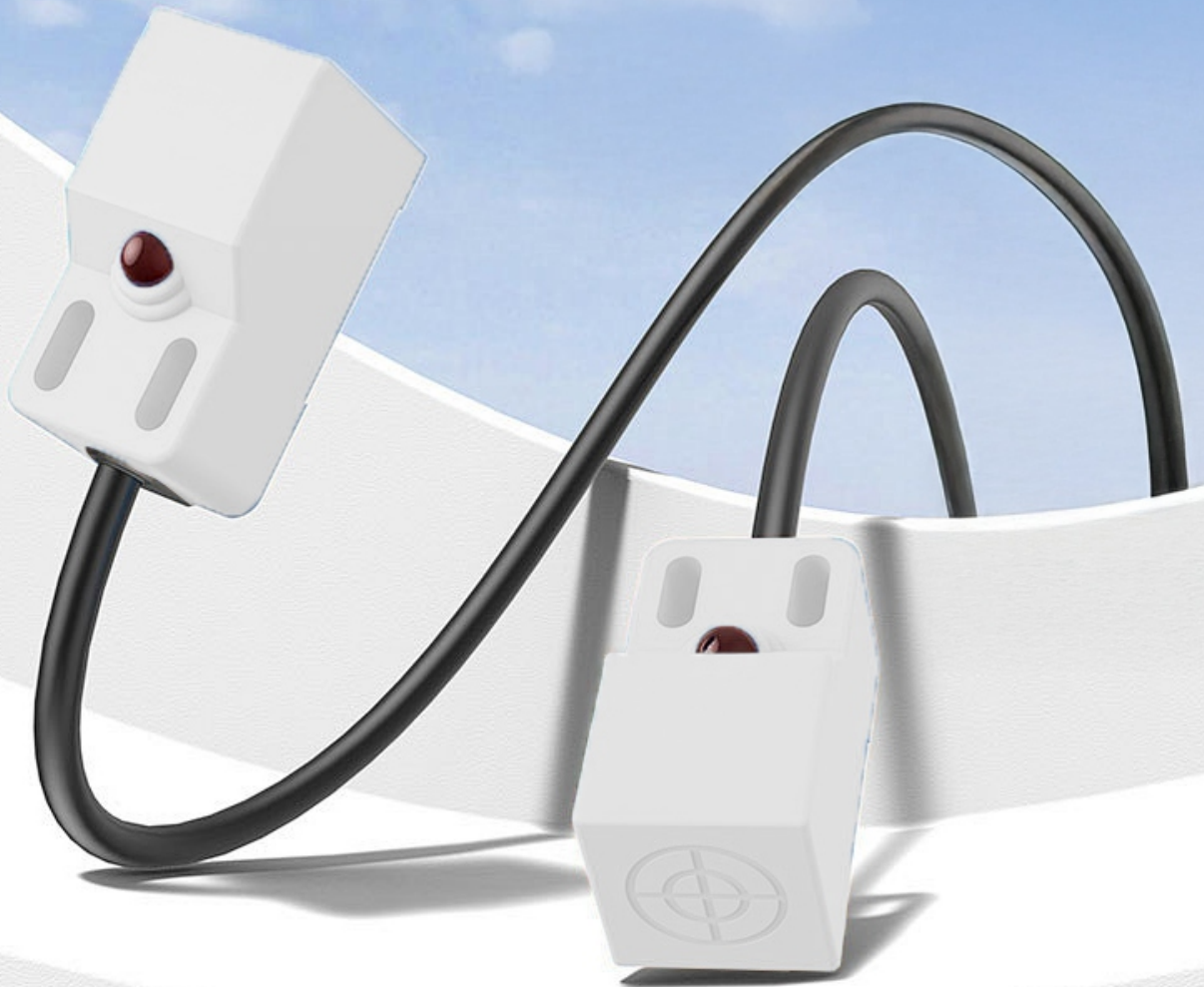

400-886-3633

[www.kacon.com.cn](http://www.kacon.com.cn)

# 电容式接近传感器 方形

KCS系列

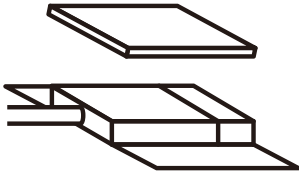

- 玻璃
- 液体
- 木材
- 塑料
- 纸
- 金属



可调节参量, 方便设置  
检测距离

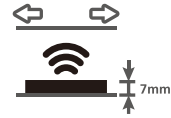

7mm高度, 适合平面狭小  
空间安装



增强防水型设计



内置放大器



可安装于金属板表面

## 型号命名

系列



系列	KCS 电容方形				
① 安装方式	无:默认非齐平式	Q:齐平式			
② 感应距离	S:0.6mm S:1-5mm F:6mm可调	A:0.8mm E:2-10mm K:8mm可调	B:1mm D:2mm可调 L:10mm	C:1.2mm G:4mm可调 N:10mm可调	D:1.5mm H:5mm可调 M:20mm可调
③ 外形尺寸	A:20.5×50.5×5.5 L:18×30×10	B:20×50×5 R:30×50×7	C:20×50×10	J:18×36×18	F:15.8×28×12.1
④ 输出方式	1:NPN N/O(输出3线)	2:NPN N/C(输出3线)	3:PNP N/O(输出3线)	4:PNP N/C(输出3线)	
⑤ 电压范围	1:10~30VDC				
⑥ 电缆方式	无:标准2m电缆 5:M12带线连接器	2:M8连接器	3:M12连接器	4:M8带线连接器	

\* 产品标准规范并不出现在产品型号描述中



## 选型指南

	1-5mm可调	2mm可调	4mm可调	5mm	5mm可调	6mm可调	8mm可调	10mm	10mm可调	20mm可调	2-20mm可调
20.5x20.5x5.5 非齐平型/齐平型									●		
20x50x5非齐平型	●			●				●			●
20x50x10齐平型									●	●	
18x36x18齐平型					●						
18x36x18非齐平型							●				
15.8x28x12.1齐平型			●								
15.8x28x12.1非齐平型						●					
18x30x10齐平型			●								
18x30x10非齐平型						●					
30x50x7齐平型						●					
30x50x7非齐平型									●		







### 一般性能

检测对象	导电介质及非导电介质（金属、木材、水、酒精、玻璃、陶瓷、PVC、油）
修正系数	金属/水=1 酒精约0.7 玻璃约0.6 陶瓷约0.5 PVC约0.4 木材0.2-0.7 油约0.25
工作电压	10-30V DC(电压波动 < 10%)
最大负载电流[mA]	200mA
空载电流[mA]	≤15mA (24V)
磁滞[Sr的百分比]	2%~20%
重复精度[Sr的百分比]	< 2%满量程
环境温度[°C]	-25 - +70°C
环境湿度	使用/储存: 35% ~ 95%RH
温度漂移[Sr的百分比]	< 10%
防护等级	IP67
极性保护/短路保护	内置/脉冲
过载保护电流[mA]	220mA
开关状态显示	LED
绝缘电阻	50MΩ以上 (DC500V电压) 导电部与外壳间
抗冲击	30gn,11ms
抗震动	55Hz,1mm amp1.,3×30min.
标准	IEC 60947-5-2 GB/T 14048.5
电缆出口	标准: 2m电缆线; M8连接器; M12连接器; M8带线连接品; M12带线连接器
配件	2个螺母







### 产品选型

型号	感应距离	形状	输出方式	响应频率	尺寸	待检测物体标准	电缆出口	产品型号
安装尺寸: 20.5方形 	N:10mm可调	齐平/非齐平	1:NPN N/O 2:NPN N/C 3:PNP N/O 4:PNP N/C	130Hz	20.5x50.5x5.5	铁20x20x1mm	标准: 2m电缆 带线M8连接器	KCS NA11 KCS NA21 KCS NA114 KCS NA214
安装尺寸: 20方形 	H:5mm	非齐平	1:NPN N/O 2:NPN N/C 3:PNP N/O 4:PNP N/C	100Hz	20x50x5	铁20x20x1mm	标准: 2m电缆	KCS HB11 KCS HB21 KCS HB31 KCS HB41

### 产品选型

型号	感应距离	形状	输出方式	响应频率	尺寸	待检测物体标准	电缆出口	产品型号
安装尺寸: 20方形 	L:10mm	非齐平	1:NPN N/O 2:NPN N/C 3:PNPN/O 4:PNPN/C	100Hz	20x50x5	铁20x20x1mm	标准: 2m电缆	KCS LB11 KCS LB21 KCS LB31 KCS LB41
安装尺寸: 20方形 	S:1-5mm 可调	非齐平	1:NPN N/O 2:NPN N/C 3:PNPN/O 4:PNPN/C	100Hz	20x50x5	铁20x20x1mm	标准: 2m电缆	KCS SB11 KCS SB21 KCS SB31 KCS SB41
安装尺寸: 20方形 	E:2-10mm 可调	非齐平	1:NPN N/O 2:NPN N/C 3:PNPN/O 4:PNPN/C	100Hz	20x50x5	铁20x20x1mm	标准: 2m电缆	KCS EB11 KCS EB21 KCS EB31 KCS EB41
安装尺寸: 20方形 	N:10mm可调	非齐平	1:NPN N/O 2:NPN N/C 3:PNPN/O 4:PNPN/C	100Hz	20x50x10	铁30x30x1mm	标准: 2m电缆	KCS NC11 KCS NC21 KCS NC31 KCS NC41
安装尺寸: 20方形 	M:20mm可调	非齐平	1:NPN N/O 2:NPN N/C 3:PNPN/O 4:PNPN/C	100Hz	20x50x10	铁30x30x1mm	标准: 2m电缆	KCS MC11 KCS MC21 KCS MC31 KCS MC41
安装尺寸: 18方形 	P:5mm可调	齐平	1:NPN N/O 2:NPN N/C 3:PNPN/O 4:PNPN/C	100Hz	18x36x18	铁18x18x1mm	标准: 2m电缆	KCS QHJ11 KCS QHJ21 KCS QHJ31 KCS QHJ41
安装尺寸: 18方形 	K:8mm可调	非齐平	1:NPN N/O 2:NPN N/C 3:PNPN/O 4:PNPN/C	100Hz	18x36x18	铁24x24x1mm	标准: 2m电缆	KCS KJ11 KCS KJ21 KCS KJ31 KCS KJ41

### 产品选型

型号	感应距离	形状	输出方式	响应频率	尺寸	待检测物体标准	电缆出口	产品型号
安装尺寸: 15.8方形 	G:4mm可调	齐平	1:NPN N/O 2:NPN N/C 3:PNPN/O 4:PNPN/C	100Hz	15.8x28x12.1	铁16x16x1mm	标准: 2m电缆	KCS QGF11 KCS QGF21 KCS QGF31 KCS QGF41
安装尺寸: 15.8方形 	F:6mm可调	非齐平	1:NPN N/O 2:NPN N/C 3:PNPN/O 4:PNPN/C	100Hz	15.8x28x12.1	铁16x16x1mm	标准: 2m电缆	KCS FF11 KCS FF21 KCS FF31 KCS FF41
安装尺寸: 18方形 	G:4mm可调	齐平	1:NPN N/O 2:NPN N/C 3:PNPN/O 4:PNPN/C	100Hz	18x30x10	铁18x18x1mm	标准: 2m电缆	KCS QGL11 KCS QGL21 KCS QGL31 KCS QGL41
安装尺寸: 18方形 	F:6mm可调	非齐平	1:NPN N/O 2:NPN N/C 3:PNPN/O 4:PNPN/C	100Hz	18x30x10	铁18x18x1mm	标准: 2m电缆	KCS FL11 KCS FL21 KCS FL31 KCS FL41
安装尺寸: 30方形 	F:6mm可调	齐平	1:NPN N/O 2:NPN N/C 3:PNPN/O 4:PNPN/C	100Hz	30x50x7	铁30x30x1mm	标准: 2m电缆	KCS QFR11 KCS QFR21 KCS QFR31 KCS QFR41
安装尺寸: 30方形 	N:10mm可调	非齐平	1:NPN N/O 2:NPN N/C 3:PNPN/O 4:PNPN/C	100Hz	30x50x7	铁30x30x1mm	标准: 2m电缆	KCS NR11 KCS NR21 KCS NR31 KCS NR41

### 外形尺寸

KCS 20.5  
20.5x50.5x5.5

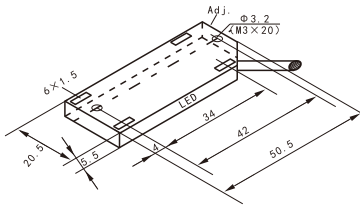

KCS 20  
20x50x5

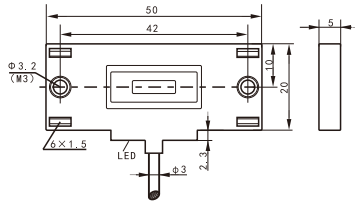

KCS 20  
20x50x5

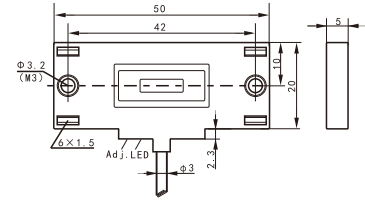

KCS 20  
20x50x10

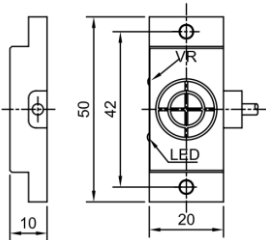

KCS 18  
18x36x18

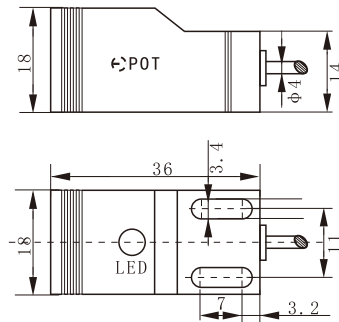

KCS 15.8  
15.8x28x12.1

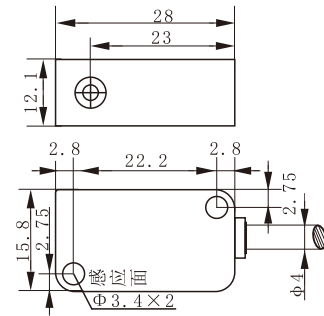

KCS 18  
18x30x10

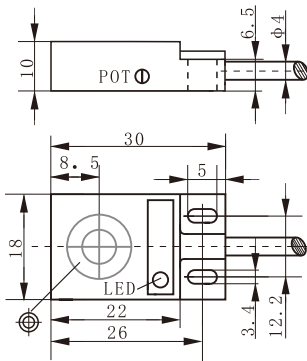

KCS 30  
30x50x7

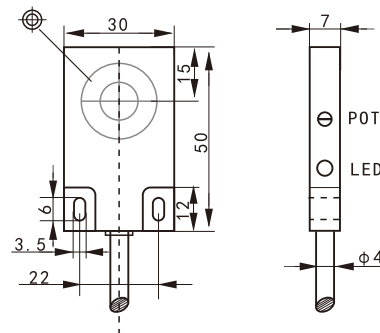

### 接线图

